

# RFM12N18, RFM12N20, RFP12N18, RFP12N20

12A, 180V and 200V, 0.250 Ohm,  
N-Channel Power MOSFETs

September 1998

## Features

- 12A, 180V and 200V
- $r_{DS(ON)} = 0.250\Omega$
- Related Literature
  - TB334 "Guidelines for Soldering Surface Mount Components to PC Boards"

## Ordering Information

PART NUMBER	PACKAGE	BRAND
RFM12N18	TO-204AA	RFM12N18
RFM12N20	TO-204AA	RFM12N20
RFP12N18	TO-220AB	RFP12N18
RFP12N20	TO-220AB	RFP12N20

NOTE: When ordering, use the entire part number.

## Description

These are N-Channel enhancement mode silicon gate power field effect transistors designed for applications such as switching regulators, switching converters, motor drivers, relay drivers and drivers for high power bipolar switching transistors requiring high speed and low gate drive power. These types can be operated directly from integrated circuits.

Formerly developmental type TA09293.

## Symbol

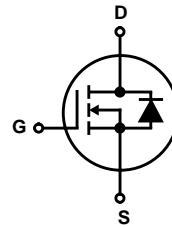

## Packaging

JEDEC TO-204AA

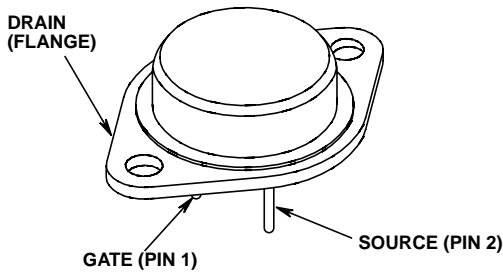

JEDEC TO-220AB

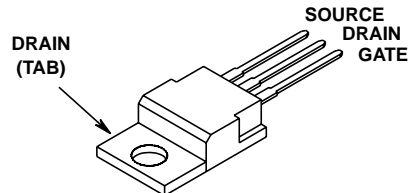

## RFM12N18, RFM12N20, RFP12N18, RFP12N20

### Absolute Maximum Ratings $T_C = 25^\circ\text{C}$ , Unless Otherwise Specified

	RFM12N18	RFM12N20	RFP12N18	RFP12N20	UNITS	
Drain to Source Voltage (Note 1) . . . . .	$V_{DSS}$	180	200	180	200	V
Drain to Gate Voltage ( $R_{GS} = 1\text{m}\Omega$ ) (Note 1) . . . . .	$V_{DGR}$	180	200	180	200	V
Continuous Drain Current . . . . .	$I_D$	12	12	12	12	A
Pulsed Drain Current (Note 3) . . . . .	$I_{DM}$	30	30	30	30	A
Gate to Source Voltage . . . . .	$V_{GS}$	$\pm 20$	$\pm 20$	$\pm 20$	$\pm 20$	V
Maximum Power Dissipation . . . . .	$P_D$	100	100	75	75	W
Linear Derating Factor . . . . .		0.8	0.8	0.6	0.6	W/ $^\circ\text{C}$
Operating and Storage Temperature . . . . .	$T_J, T_{STG}$	-55 to 150	-55 to 150	-55 to 150	-55 to 150	$^\circ\text{C}$
Maximum Temperature for Soldering						
Leads at 0.063in (1.6mm) from Case for 10s . . . . .	$T_L$	300	300	300	300	$^\circ\text{C}$
Package Body for 10s, See Techbrief 334 . . . . .	$T_{pkg}$	260	260	260	260	$^\circ\text{C}$

*CAUTION: Stresses above those listed in "Absolute Maximum Ratings" may cause permanent damage to the device. This is a stress only rating and operation of the device at these or any other conditions above those indicated in the operational sections of this specification is not implied.*

**NOTE:**

- $T_J = 25^\circ\text{C}$  to  $125^\circ\text{C}$ .

### Electrical Specifications $T_C = 25^\circ\text{C}$ , Unless Otherwise Specified

PARAMETER	SYMBOL	TEST CONDITIONS	MIN	TYP	MAX	UNITS
Drain to Source Breakdown Voltage RFM12N18, RFP12N18	$BV_{DSS}$	$I_D = 250\mu\text{A}, V_{GS} = 0\text{V}$	180	-	-	V
			RFM12N20, RFP12N20	200	-	-
Gate Threshold Voltage	$V_{GS(TH)}$	$V_{GS} = V_{DS}, I_D = 250\mu\text{A}$ , (Figure 8)	2	-	4	V
Zero Gate Voltage Drain Current	$I_{DSS}$	$V_{DS} = \text{Rated } BV_{DSS}, V_{GS} = 0\text{V}$ $V_{DS} = 0.8 \times \text{Rated } BV_{DSS}, V_{GS} = 0\text{V}$ , $T_C = 125^\circ\text{C}$	-	-	1	$\mu\text{A}$
			-	-	25	$\mu\text{A}$
Gate to Source Leakage Current	$I_{GSS}$	$V_{GS} = \pm 20\text{V}, V_{DS} = 0\text{V}$	-	-	$\pm 100$	nA
Drain to Source On Resistance (Note 2)	$r_{DS(ON)}$	$I_D = 12\text{A}, V_{GS} = 10\text{V}$ , (Figures 6, 7)	-	-	0.250	$\Omega$
Drain to Source On Voltage (Note 2)	$V_{DS(ON)}$	$I_D = 12\text{A}, V_{GS} = 10\text{V}$	-	-	3.0	V
Turn-On Delay Time	$t_{d(ON)}$	$V_{DD} = 100\text{V}, I_D \approx 6\text{A}, R_G = 50\Omega$ , $R_L = 16.5\Omega, V_{GS} = 10\text{V}$ , (Figures 10, 11, 12)	-	35	50	ns
Rise Time	$t_r$		-	130	200	ns
Turn-Off Delay Time	$t_{d(OFF)}$		-	120	180	ns
Fall Time	$t_f$		-	105	160	ns
Input Capacitance	$C_{ISS}$	$V_{DS} = 25\text{V}, V_{GS} = 0\text{V}, f = 1\text{MHz}$ , (Figure 9)	-	-	1700	pF
Output Capacitance	$C_{OSS}$		-	-	600	pF
Reverse Transfer Capacitance	$C_{RSS}$		-	-	300	pF
Thermal Resistance Junction to Case	$R_{\theta JC}$	RFM12N18, RFM12N20	-	-	1.25	$^\circ\text{C/W}$
		RFP12N18, RFP12N20	-	-	1.67	$^\circ\text{C/W}$

### Source to Drain Diode Specifications

PARAMETER	SYMBOL	TEST CONDITIONS	MIN	TYP	MAX	UNITS
Source to Drain Diode Voltage (Note 2)	$V_{SD}$	$I_{SD} = 6\text{A}$	-	-	1.4	V
Reverse Recovery Time	$t_{rr}$	$I_{SD} = 4\text{A}, dI_{SD}/dt = 100\text{A}/\mu\text{s}$	-	325	-	ns

**NOTE:**

- Pulsed: pulse width  $\leq 300\mu\text{s}$  maximum, duty cycle  $\leq 2\%$ .
- Repetitive rating: pulse width is limited by maximum junction temperature.

**Typical Performance** Curves Unless Otherwise Specified

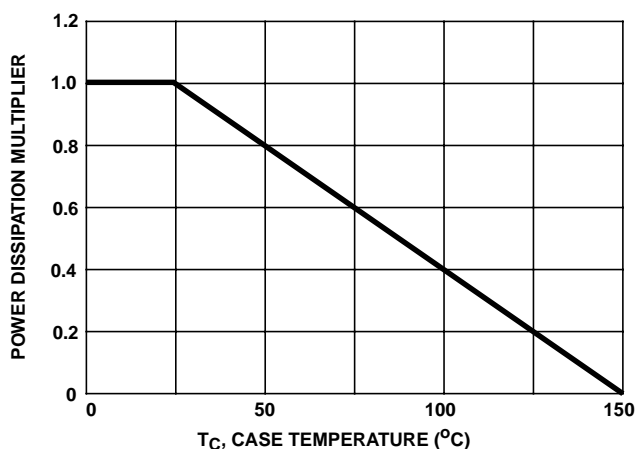

FIGURE 1. NORMALIZED POWER DISSIPATION vs CASE TEMPERATURE

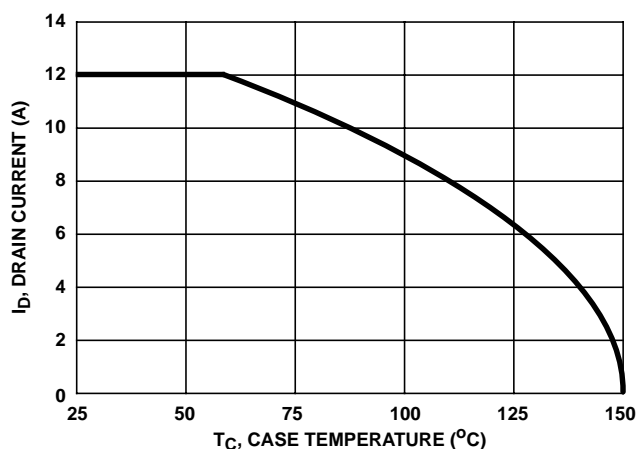

FIGURE 2. MAXIMUM CONTINUOUS DRAIN CURRENT vs CASE TEMPERATURE

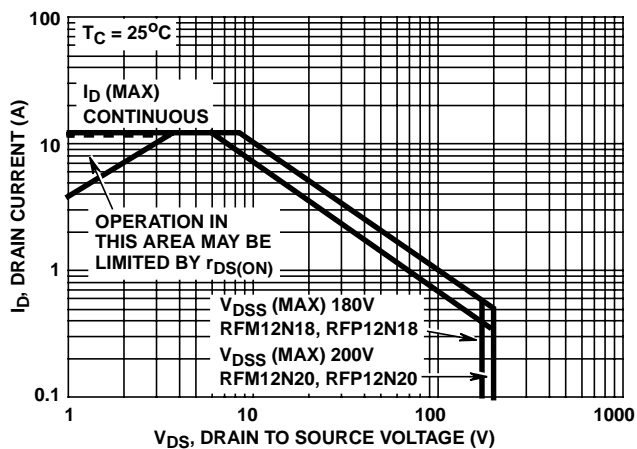

FIGURE 3. FORWARD BIAS SAFE OPERATING AREA

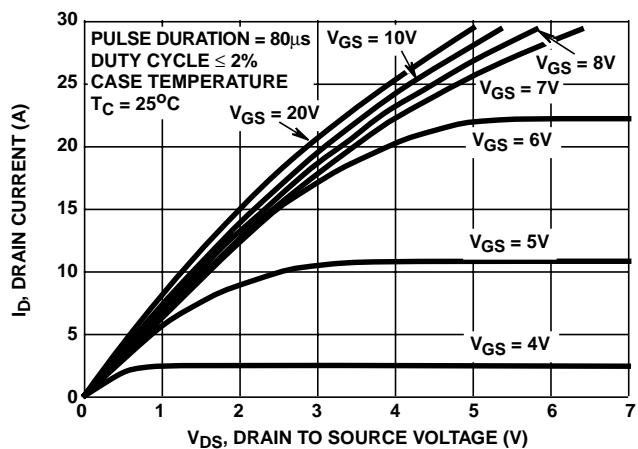

FIGURE 4. SATURATION CHARACTERISTICS

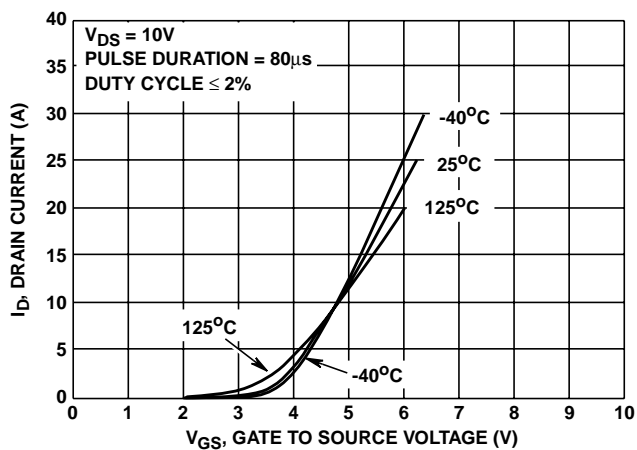

FIGURE 5. TRANSFER CHARACTERISTICS

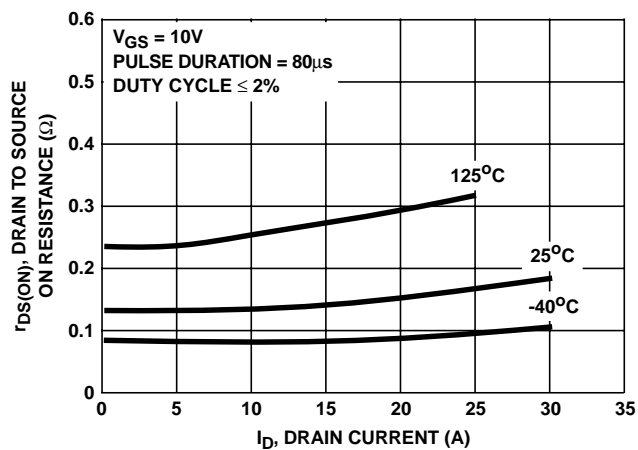

FIGURE 6. DRAIN TO SOURCE ON RESISTANCE vs GATE VOLTAGE AND DRAIN CURRENT

**Typical Performance** Curves Unless Otherwise Specified (Continued)

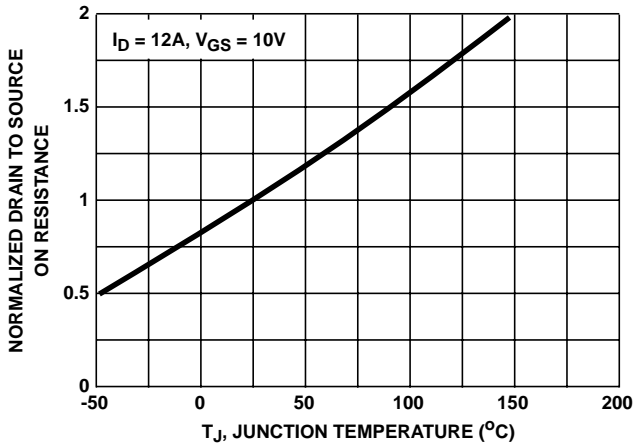

FIGURE 7. NORMALIZED DRAIN TO SOURCE ON RESISTANCE vs JUNCTION TEMPERATURE

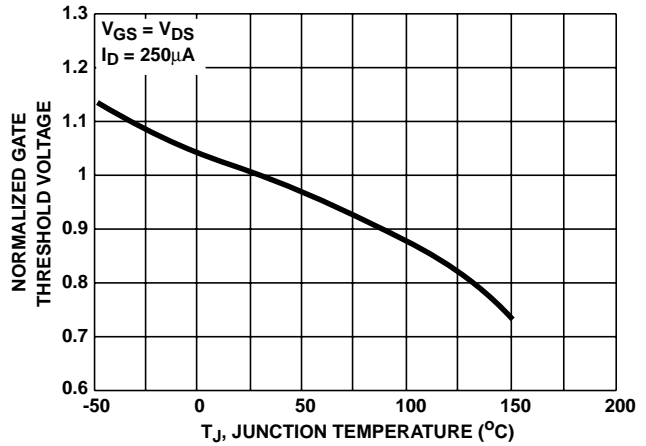

FIGURE 8. NORMALIZED GATE THRESHOLD VOLTAGE vs JUNCTION TEMPERATURE

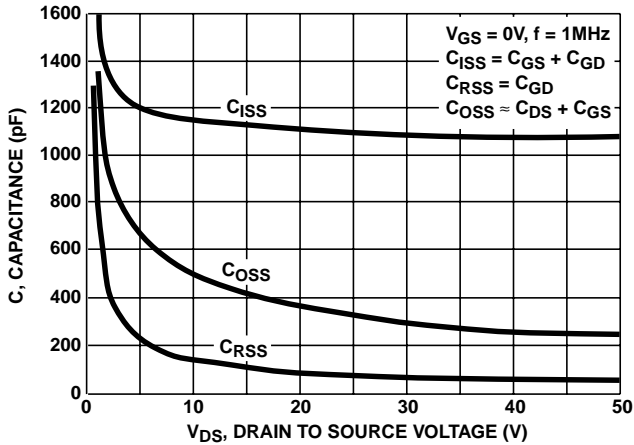
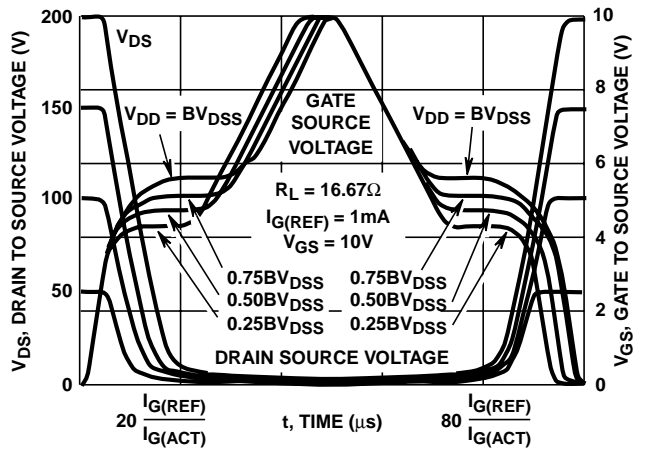

FIGURE 9. CAPACITANCE vs DRAIN TO SOURCE VOLTAGE



NOTE: Refer to Harris Application Notes AN7254 and AN7260.  
FIGURE 10. NORMALIZED SWITCHING WAVEFORMS FOR CONSTANT GATE CURRENT

**Test Circuits and Waveforms**

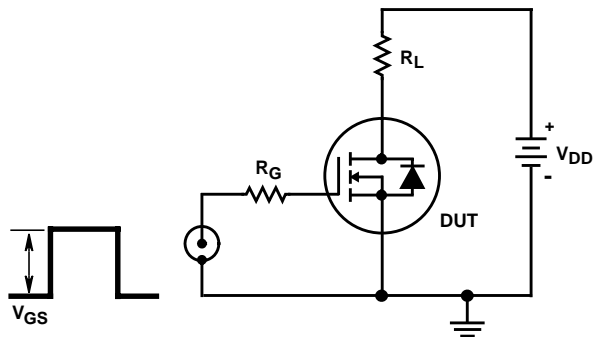

FIGURE 11. SWITCHING TIME TEST CIRCUIT

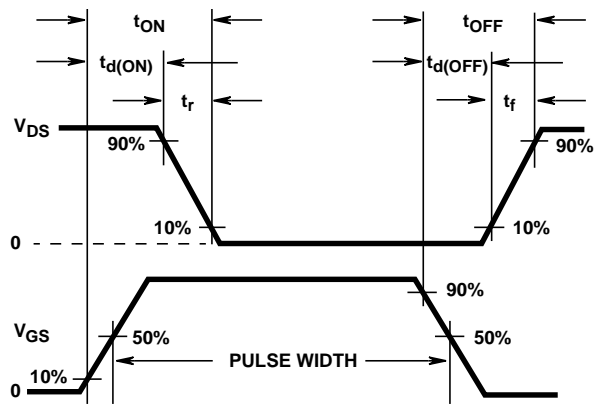

FIGURE 12. RESISTIVE SWITCHING WAVEFORMS